

T-937M lead-free reflow oven user manual



User Manual

1. Parameters	3
2. Configuration.....	3
3. Main parts	3
4. Installation.....	4
5. Software Interface	4
6. Manual Instruction	6
7. Attention	9
8. Warranty.....	9
Declaration	9

1. Parameters

Soldering area	350mmX400mm
Dimension	473mmX466mmX290mm
N. Weight	20.7kg
Voltage/Frequency	AC220~230V/50~60Hz
Power rating	3300W
Cycle time	2~16 min
Temp rage	Room temp~350°C

2. Configuration

Name	Q'ty
T-937M lead-free reflow oven	1
Power line	1
fuse	1
CD	1
COM communication line	1

3. Main parts

Mainbody



①Operation panel ②Drawer ③COM

Operation Panel



① Indicator light ② Display ③ Key

Others



① Exhaust ② Switch ③ Power line

4. Installation

- i. Please put this reflow oven on the flat tabletop.
- ii. Please put this reflow oven in safe environment, not flammable or combustible.
- iii. Please leave 20mm around the machine, for heat dissipation.
- iv. The machine must be connected with Earth wire.

5. Software Interface

Main Interface

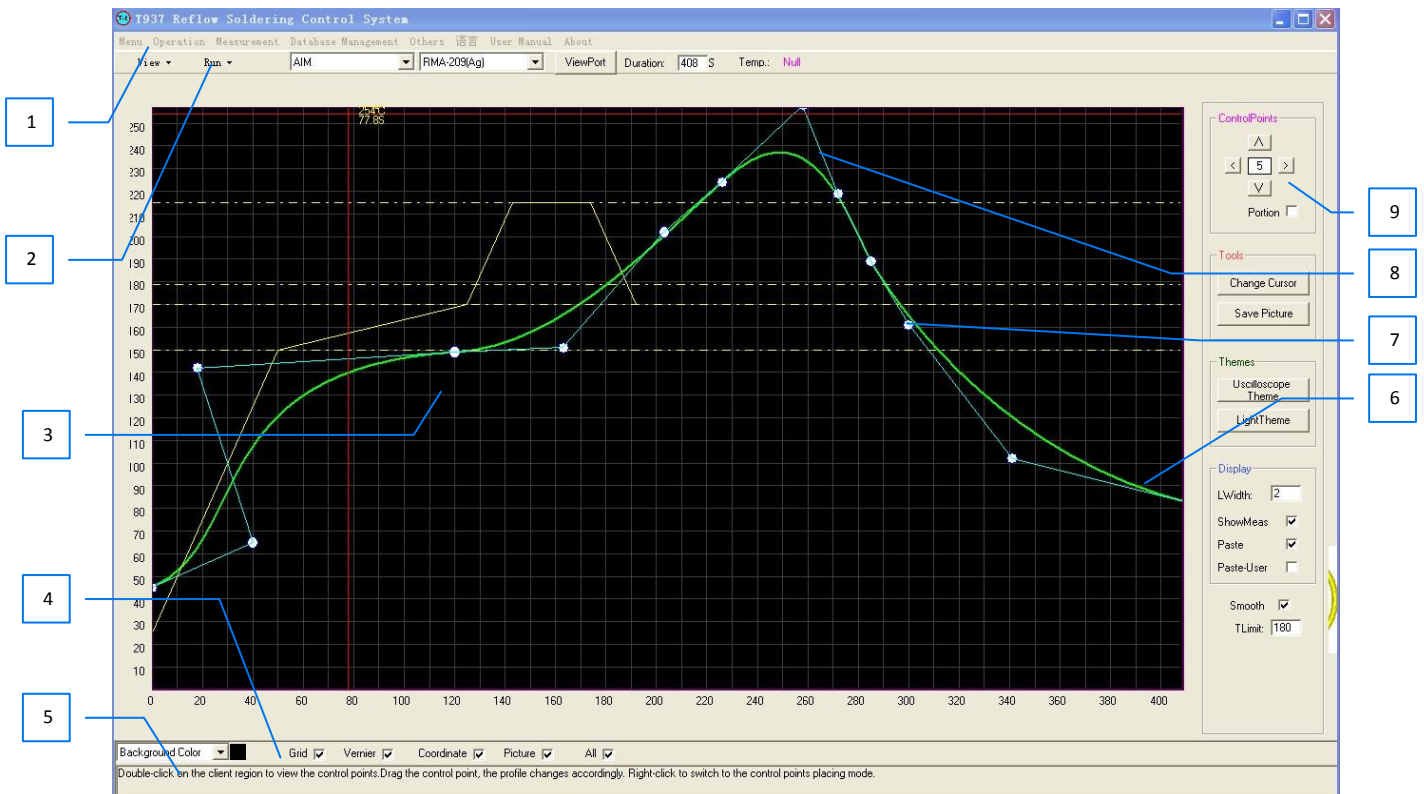

- 1: Menu bar 2: Shortcut bar 3: client drawing area 4: display setting area 5: operation tip area 6: T-t data wave 7: control point 8: control point line
9: toolbar

The client drawing area

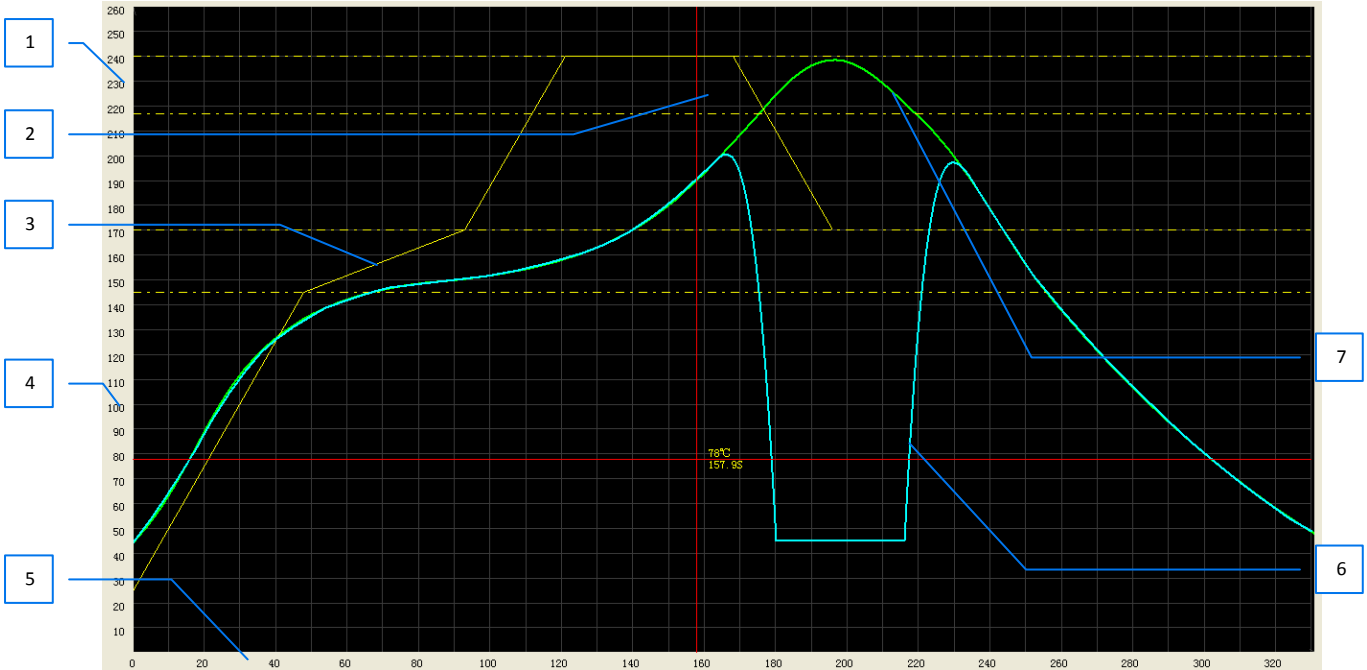

- 1: temp axis 2: cursor 3: solder paste character wave 4: coordinate display 5: time axis 6: effected wave 7: wave graph

Shortcut bar

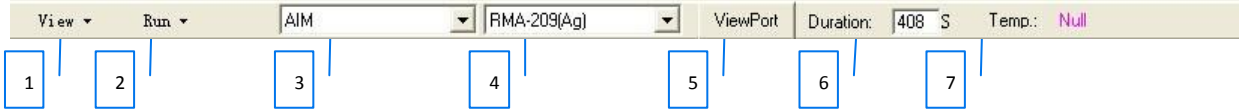

- 1: check machine memory wave 2: run the machine memory wave 3: solder paste brand 4: solder paste model
5: re-set viewport 6: set cycle time 7: current oven temp

Display setting area

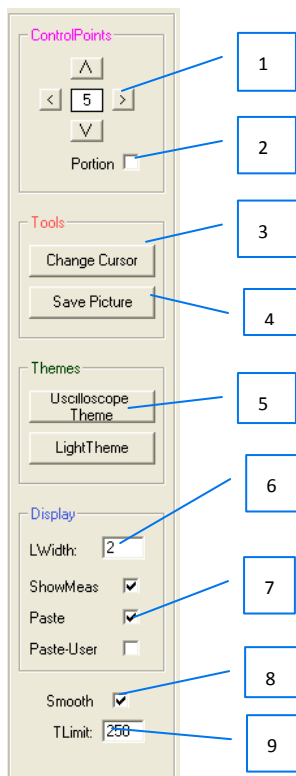

- 1: control points moving direction
2: partially/completely move the control point
3: change to set control point cursor
4: save pic in client drawing area
5: show topics
6: wave line width
7: paste

8: smooth wave

9: temp setting range

6. Manual Instruction

i. Install RS232 driver

Please see the CD-“usb driverV3.1”

ii. Install the software

Open the CD, find the “T-937 回流焊控制系统.exe (T-937 Reflow Soldering Control System.exe)”, double-click, start to install.

iii. Software Operation

1) Viewport setting

After open the software, you will see the “viewport setting”, in order to get good visual effect, please set the time parameter of viewport to “reflow target time +10S”, set the temp parameter to “target peak temp+20°C, press “confirm”

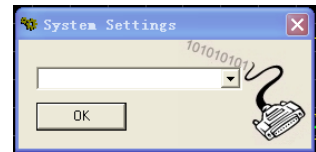

2) Operation with PC

Please use the communication line to connect with computer.

Open T-937M software, press menu bar-other function-system parameter, open the setting window.

Select “USB-SERIAL CH340 (COM**)*”, press “confirm” and return to main interface, you will see like this 初始化 USB-SERIAL CH340 (COM10) 成功 in the shortcut bar, then press F2 on the reflow oven, T-937M reflow oven LCD displayer will show “connected with PC”, also you will see 联机成功 in the software, connect successfully.

3) Make the wave

① Set the solder paste character

click “Display setting area -7 paste”, the wave will display in the client drawing area. Click “display setting area – paste user”, it will show the user-defined paste character, or the the paste character from the paste database.

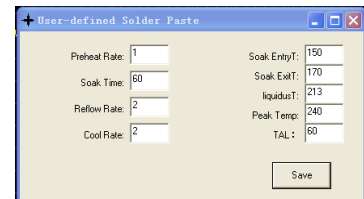

a) Use the paste database from software

Select the paste model from the shortcut bar, the paste wave will display in client drawing area.

b) User define paste data

Click “others” –“ user defined solder paste”, it will show “user defined paste window”, fill in the paste parameters you use, click “save”. This wave will display in the client draw area.

② Set up the wave

a) open the wave from machine memory

Click “menu” – “open recipe”, select the wave you want to use.

Tips: this machine is with 8 waves inside, if these 8 waves can not match your solder paste, please adjust the wave in order to match with your solder paste, get good reflow effect.

b) Set up wave

Under “place control points state”, the mouse cursor will change to  (click the right mouse button to switch “place/check control points state”), then click in the client draw area, place the control point, set up new wave.

③ Adjust the wave

a) Under “check control points state”, double click the client draw area, it will show many control points on the wave, use the mouse to move the control points, the wave will change.

b) also you can use  to adjust the wave in different direction, it can change the wave fastly.

Tips: the paste character wave show the theoretical wave, in fact, due to the influence of various

factors such as heat conduction rate, so please adjust the wave according to the actually reflow effect, in order to get perfect soldering effect.

④ Preview the wave

Please click “operation” – “profile preview” to check the wave which the user made if it meets request, if the temps are over the “T Limit” (in the display setting area, No.9) , this software will set these temps to 45°C automatically.

⑤ Set the wave heating time

Please set the heating time in the shortcut bar – Duration: 600 S

⑥ Save the wave

Click “menu”-“save recipe”, fill in the wave name, press “save”.

⑦ Manager the wave

Click “database management”-“recipe management” , will display the wave management window.

4) Send the wave to T-937M reflow oven

T-937M reflow oven has 8 file areas for saving the waves, if not connect with PC, T-937M reflow oven can perform the wave independently.

After making the wave in the computer side, click “operation” –“send to device” , select the profile No. to send.

5) View the waves in machine

Click the “view” , select the profile No, this wave will display in the client drawing area, then you can adjust the wave here, and save it.

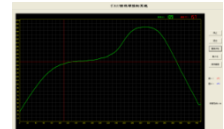

6) Run the wave in machine

Click the “run” in the shortcut bar, select the profile No, it will show wave running window, start soldering.

iv. Independent Operation

Panel



Interface

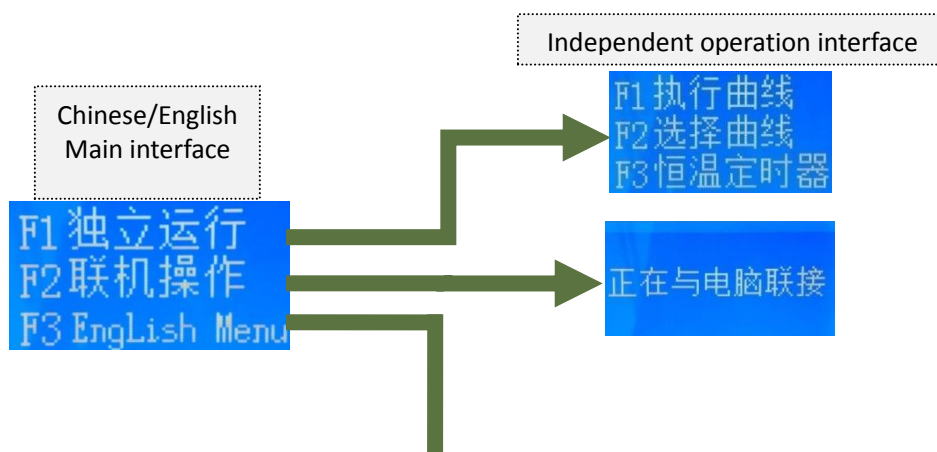

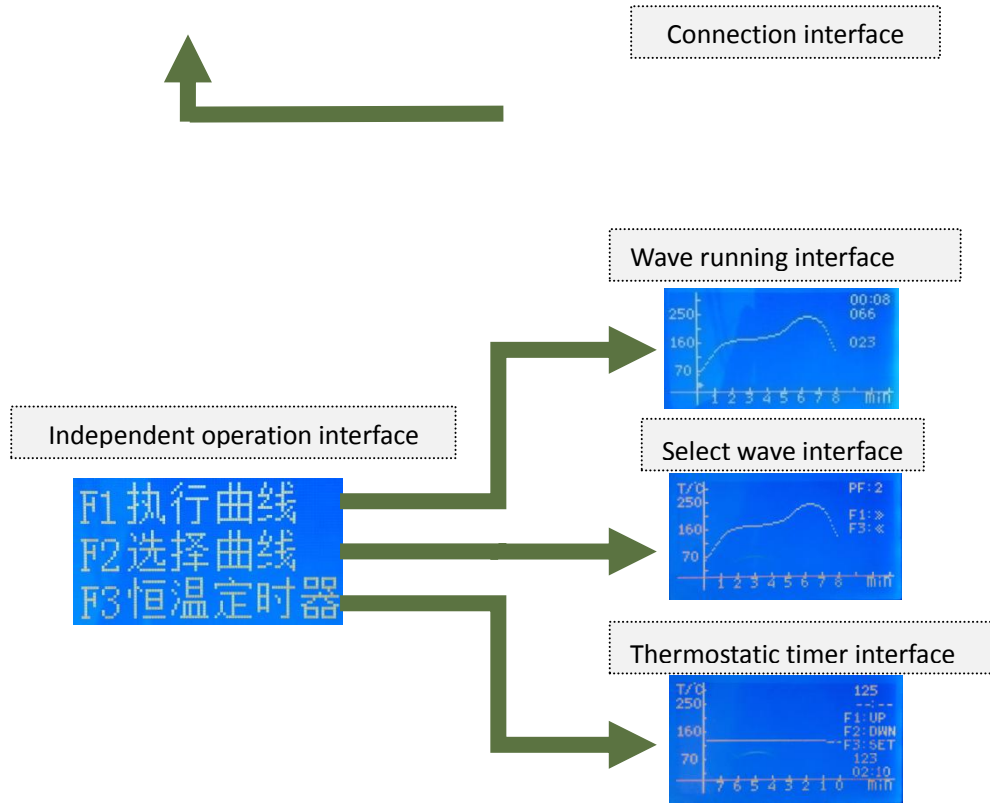

The main interface

performing the wave interface

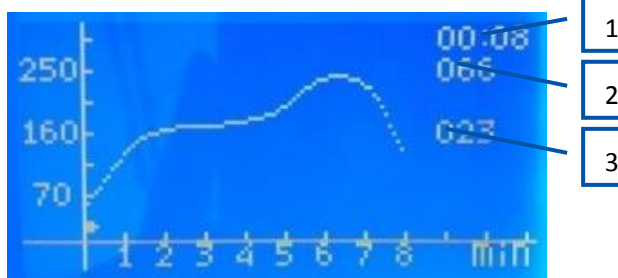

1、running time 2、set temp 3、current temp

Selecting wave interface

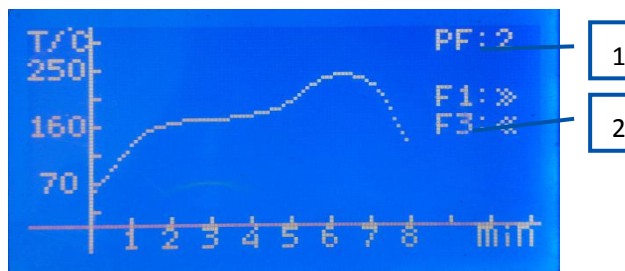

1、 wave number 2、 operation tips(F1/select next wave ; F3/select last wave; F2:switch last/next 8 mins wave)

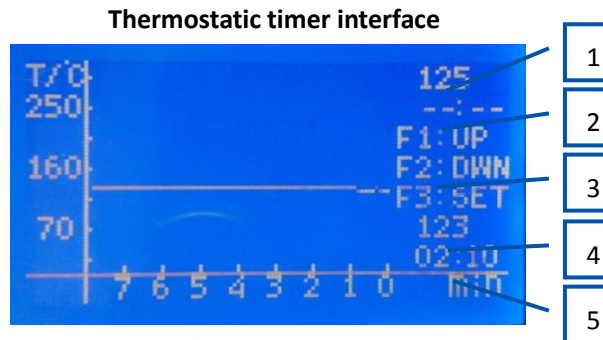

- 1、Set temp 2、 set time (---:-- is untimed model) 3、 operation tips (F1/ up, F2/ down, F3/switch set temp or set time 4、 current temp 5、 current running time

Operation

- 1) Enter the software interface

Press F1, will come to the independent operation interface

- 2) Select the wave

Under the independent operation interface, press F2 to select wave, press F1 and F3 to select the wave you need, then press “return key” to independent operation interface.

- 3) Run the wave

Under the independent operation interface, press F1, it will run the wave you selected.

- 4) Thermostatic timer function

Under the independent operation interface, press F3, start the thermostatic timer function.

Thermostatic timer function means the machine can keep thermostatic temp if you set time, once time over, the machine stop heating.

Press F3 change “set temp”/”set time”, press F1/F2 to adjust the numerical value, the time is---:-- is untimed model, means the machine is keeping thermostatic heating, not stop automatically.

- 5) Change language

Under the main interface, press F3 to change the language.

7. Attention

- i. If not use this machine for long time, please unplug the power line plug.
- ii. The machine should be connected to the exhaust passage within the outdoor ventilation or exhaust recovery, prevent solder paste volatiles poisoning.
- iii. This machine is with strict protective insulation materials, please don't open the machine casually.

8. Warranty

The warranty for mainbody is one year, for parts is three months, provide lifetime technical guide.

Declaration

If there is inconsistency between this user manual and the actual product, the actual product shall govern.